

SPECIAL OFFER November 2017/ Lagerabverkaufsangebot November 2017









article/Artikel	article specification/Artikelbeschreibung	article image/Abbildung	quantity/ Menge	special net price/ Sonder- nettopreis (€)
00G050x-06	Polyamide wheel black; Wheel diameter 50mm; Tread width 18mm; Hub width 21,5mm; Bore diameter 6mm; Solid bearing; load capacity 50kg Polyamid Rad schwarz; Raddurchmesser 50mm; Laufflächenbreite 18mm; Nabenlänge 21,5mm; Achsbohrung 6mm; Gleitlager; Tragkraft 50kg		8000	0,08
00G080p	Polyamide wheel white; Wheel diameter 80mm; Tread width 33mm; Hub width 36mm; Bore diameter 12mm; Solid bearing; load capacity 100kg Polyamid Rad weiß; Raddurchmesser 80mm; Laufflächenbreite 33mm; Nabenlänge 36mm; Achsbohrung 12mm; Gleitlager; Tragkraft 100kg		2000	0,49
00G125p-32	Polyamide wheel white; Wheel diameter 125mm; Tread width 32mm; Hub width 35mm; Bore diameter 12mm; Solid bearing; load capacity 125kg Polyamid Rad weiß; Raddurchmesser 125mm; Laufflächenbreite 32mm; Nabenlänge 35mm; Achsbohrung 12mm; Gleitlager; Tragkraft 125kg		700	1,51
00R100p-35	Polyamide wheel white; Wheel diameter 100 mm; Tread width 35mm; Hub width 36,5 mm; Bore diameter 12 mm; Roller bearing; load capacity 125 kg Polyamid Rad weiss; Raddurchmesser 100 mm; Laufflächenbreite 35mm; Nabenlänge 36,5 mm; Achsbohrung 20 mm; Rollenlager; Tragkraft 400 kg;		1.000	1,51
00R150x	Polyamide wheel black; Wheel diameter 150 mm; Tread width 45mm; Hub width 58 mm; Bore diameter 20 mm; Roller bearing; load capacity 400 kg Polyamid Rad schwarz; Raddurchmesser 150 mm; Laufflächenbreite 45mm; Nabenlänge 58 mm; Achsbohrung 20 mm; Rollenlager; Tragkraft 400 kg;		186	1,27
08R125cZ-5	Solid rubber tyre black; sheet steel metal rim zink passivated; Wheel diameter 125mm; Tread width 28mm; Hub width 49mm; Bore diameter 14mm; roller bearing; load capacity 120kg Vollgummireifen schwarz; Stahlbelchfelge verzinkt-passiviert; Raddurchmesser 125mm; Laufflächenbreite 28mm; Nabenlänge 49mm; Achsbohrung 14mm; Rollenlager; Tragkraft 120kg;		650	0,54
08R125bZ-5	Solid rubber tyre grey; sheet steel metal rim zink passivated; Wheel diameter 125 mm; Tread width 28 mm; Hub width 49 mm; Bore diameter 14 mm; roller bearing; load capacity 120 kg Vollgummireifen blaugrau; Stahlbelchfelge verzinkt-passiviert; Raddurchmesser 125 mm; Laufflächenbreite 28 mm; Nabenlänge 49 mm; Achsbohrung 14 mm; Rollenlager; Tragkraft 120 kg;		263	1,20







08R180cz-5	<p>solid rubber tyre black (Shore A80); sheet steel metal rim zink passivated; Wheel diameter 180mm; Tread width 45mm; Hub width 59mm; Bore diameter 20mm; roller bearing; load capacity 170kg</p> <p>Vollgummireifen schwarz (Shore A80); Stahlbelchfelge verzinkt-passiviert; Raddurchmesser 180mm; Laufflächenbreite 45mm; Nabenlänge 59mm; Achsbohrung 20mm; Rollenlager; Tragkraft 170kg</p>		260	2,07
08R200b-20Z-5	<p>Solid rubber tyre grey; sheet steel metal rim zink passivated; Wheel diameter 200mm; Tread width 30mm; Hub width 58mm; Bore diameter 20mm; roller bearing; load capacity 230g</p> <p>Vollgummireifen blaugrau ; Stahlbelchfelge verzinkt-passiviert; Raddurchmesser 200mm; Laufflächenbreite 30mm; Nabenlänge 58mm; Achsbohrung 20mm; Rollenlager; Tragkraft 230kg;</p>		156	3,06
14K150aC	<p>>easy rolling wheel- electrically conductive rubber black, Shore A75, free of contact discoloration, plastic wheel centre black, metal thread guard zinc passivated, two precision ball bearings, wheel diameter 150mm; Hub width 37mm; Bore diameter 8mm; load capacity 120kg</p> <p>>Leichtlaufrad- elektrisch-leitfähiger Gummi schwarz, Shore A75, kontaktverbindungsfrei, Kunststoff-Radkörper schwarz, Metallfladenschutz verchromt, zwei Präzisionskugellager, Raddurchmesser 150mm; Nabenlänge 37mm; Achsbohrung 8mm; Tragkraft 120kg</p>		400	11,18
1 14K160b-12	<p>elastic solid rubber tyre blue-grey, ShoreA64, vulcanised firmly on plastic wheel centre, black, precision ball bearing; wheel diameter 160mm; Hub width 59mm; Bore diameter 12mm; load capacity 250kg</p> <p>Elastisch-Vollgummireifen aufvulkanisiert blaugrau ShoreA64, Kunststoffradkörper schwarz; Präzisionskugellager; Raddurchmesser 160mm; Nabenlänge 59mm; Achsbohrung 12mm; Tragkraft 250kg</p>		75	12,49
288a 810 7588	<p>Swivel TwinCasters, Plastic polyamide housing (RAL7035), TPU tyre, wheel diameter 75 mm; wheel tread: 2x13, load capacity 60kg, total height 87mm, fitting available: plate 38x38 (hole: 25x25) and pin 11x20 - please note on order</p> <p>Doppelrolle, Gehäuse Polyamid (RAL7035), TPU Bandage, Raddurchmesser 75 mm, Radbreite: 2x13, Tragkraft 60 kg, Bauhöhe 87 mm; verfügbare Befestigungen: Platte 38x38 (25x25) und Stift 11x20 - bitte bei der Bestellung mit angeben</p>		500	1,33
288b 810 7588	<p>Swivel TwinCasters with wheel brake, Plastic polyamide housing (RAL7035), TPU tyre, wheel diameter 75 mm; wheel tread: 2x13, load capacity 60kg, total height 87mm, lose fitting available: plate 38x38 (hole: 25x25) and pin 11x20 - please note on order</p> <p>Doppelrolle mit Radstopp, Gehäuse Polyamid (RAL7035), TPU Bandage, Raddurchmesser 75 mm, Radbreite: 2x13, Tragkraft 60 kg, Bauhöhe 87 mm; verfügbare lose Befestigungen: Platte 38x38 (25x25) und Stift 11x20 - bitte bei der Bestellung mit angeben</p>		1400	1,44
340a00G050xZPB	<p>swivel castor; sheet steel metal zinc-passivated; Swivel bearing with double ball race; Top plate 54x54 mm; hole distance 40x40 mm; hole diameter 6,3 mm; Polyamide tyre black; solid bearing; Wheel diameter 50 mm; Tread width 18 mm; Total height 70 mm; load capacity 40 kg</p> <p>Lenkrolle; Stahlblechgehäuse verzinkt-passiviert; Schwenklager mit zweireihigem Kugellauf; Plattenbefestigung 54x54 mm; Schraublochentfernung 40x40 mm; Schraublochdurchmesser 6,3 mm; Polyamid Rad schwarz; Gleitlager; Raddurchmesser 50 mm; Laufflächenbreite 18mm; Bauhöhe 70 mm, Tragkraft 40 kg</p>		84	0,84
340a33G050bZKB	<p>swivel castor; sheet steel metal zinc-passivated; Swivel bearing with double ball race; 11mm pin for nylon sockets; length 33,4mm; Solid rubber tyre blue-grey; solid bearings; Wheel diameter 50 mm; Tread width 18mm; total height 70mm; load capacity 40 kg</p> <p>Lenkrolle; Stahlblechgehäuse verzinkt-passiviert; Schwenklager mit zweireihigem Kugellauf; Rohreinstechhülsestift 11mm; Länge 33,4mm; Vollgummireifen blau-grau; Gleitlager; Raddurchmesser 50 mm; Laufflächenbreite 18mm; Bauhöhe 70mm; Tragkraft 40 kg</p>		1000	0,85



340a29G075rZLC-5	swivel castor; sheet steel metal zinc-passivated; Swivel bearing with double ball race; Bolt hole 10,5mm; TPE tyre on plastic centre; plain bearing; Wheel diameter 75mm; Tread width 25mm; Total height 98mm; load capacity 60kg Lenkrolle; Stahlblechgehäuse verzinkt-passiviert; Schwenklager mit zweireihigem Kugellauf; Rückenloch 10,5mm; TPE Bandage auf Kunststoffradkörper; Gleitlager; Raddurchmesser 75mm; Laufflächenbreite 25mm; Bauhöhe 98mm, Tragkraft 60kg		900	0,68
356h29G050rZLC	swivel castor with total brake; sheet steel metal zinc-passivated; Swivel bearing with double ball race; Bolt hole 10,5 mm; TPE tyre RAL 7011; plastic wheel centre RAL 7001; Solid bearing; Wheel diameter 50 mm; Tread width 18 mm; Total height 95 mm; load capacity 50 kg Lenkrolle mit Totalfeststeller nachlaufend; Stahlblechgehäuse verzinkt-passiviert; Schwenklager mit zweireihigem Kugellauf; Rückenloch 10,5 mm; TPE Bandage RAL 7011; Kunststoff-Radkörper silbergrau RAL 7001; Gleitlager; Raddurchmesser 50 mm; Laufflächenbreite 18 mm; Bauhöhe 69 mm, Tragkraft 50 kg		83	0,98
360a33G050bZLC	Double swivel castor; sheet steel metal, zinc-passivated; Swivel bearing with double ball race; Bolt hole 10 mm; Solid rubber tyre bleu-grey; solid bearings; Wheel diameter 50 mm; Tread width 2x18 mm; total height 73 mm; offset 25 mm; load capacity 60 kg Doppellenkrolle; Stahlblech verzinkt-passiviert; Schwenklager mit zweireihigem Kugellauf; Rückenloch 10 mm; Vollgummireifen blau-grau; Gleitlager; Raddurchmesser 50 mm; Laufflächenbreite 2x18 mm; Bauhöhe 73 mm; Ausladung 25 mm; Tragkraft 60 kg		480	1,08
357a29K125rZLC	swivel castor; sheet steel metal zinc-passivated; Swivel bearing with double ball race; Bolt hole 10,2mm; TPE tyre on plastic centre; precision ball bearing; Wheel diameter 125mm; Tread width 32mm; Total height 154mm; load capacity 100kg Lenkrolle; Stahlblechgehäuse verzinkt-passiviert; Schwenklager mit zweireihigem Kugellauf; Rückenloch 10,2mm; TPE Bandage auf Kunststoffradkörper; Präzisionskugellager; Raddurchmesser 125mm; Laufflächenbreite 32mm; Bauhöhe 154mm, Tragkraft 100kg		70	2,33
357h29K125rZLC	swivel castor with total brake ; sheet steel metal zinc-passivated; Swivel bearing with double ball race; Bolt hole 10,2mm; TPE tyre on plastic centre; precision ball bearing; Wheel diameter 125mm; Tread width 32mm; Total height 154mm; load capacity 100kg Lenkrolle mit Totalfeststeller; Stahlblechgehäuse verzinkt-passiviert; Schwenklager mit zweireihigem Kugellauf; Rückenloch 10,2mm; TPE Bandage auf Kunststoffradkörper; Präzisionskugellager; Raddurchmesser 125mm; Laufflächenbreite 32mm; Bauhöhe 154mm, Tragkraft 100kg		200	3,55
362a36K125bZLD	swivel castor; sheet steel metal zinc-passivated; Swivel bearing with double ball race; Bolt hole 12,2mm; rubber tyre on plastic centre; precision ball bearing; Wheel diameter 125mm; Tread width 32mm; Total height 155mm; load capacity 100kg Lenkrolle; Stahlblechgehäuse verzinkt-passiviert; Schwenklager mit zweireihigem Kugellauf; Rückenloch 12,2mm; Vollgummi Bandage auf Kunststoffradkörper; Präzisionskugellager; Raddurchmesser 125mm; Laufflächenbreite 32mm; Bauhöhe 155mm, Tragkraft 100kg		220	2,09
439a08R100cZPG-5	fixed castor; sheet steel metal zinc-passivated; Top plate 100x84mm; hole distance 80x60mm; hole diameter 9mm; solid rubber wheel black, Shore A 80; sheet steel metal rim zinc passivated, roller bearing, wheel diameter 100mm, tread width 22mm; Total height 128mm; load capacity 90kg Bockrolle; Stahlblechgehäuse verzinkt-passiviert; Plattenbefestigung 100x84mm; Schraublochentfernung 80x60mm; Schraublochdurchmesser 9mm, Vollgummibandage schwarz, Shore A 80, Stahlblechfelge verzinkt-passiviert, Rollenlager, Raddurchmesser 100mm, Laufflächenbreite 22mm; Bauhöhe 128mm; Tragkraft 90kg		1.200	1,14
441h08R100cZPH-5	braked swivel castor; sheet steel metal zinc-passivated; Top plate 100x84mm; hole distance 80x60mm; hole diameter 9mm; solid rubber wheel black, Shore A 80; sheet steel metal rim zinc passivated, roller bearing, wheel diameter 100mm, tread width 22mm; Total height 128mm; load capacity 90kg Lenkrolle mit Totalfeststeller nachlaufend; Stahlblechgehäuse verzinkt-passiviert; Plattenbefestigung 100x84mm; Schraublochentfernung 80x60mm; Schraublochdurchmesser 9mm, Vollgummibandage schwarz, Shore A 80, Stahlblechfelge verzinkt-passiviert, Rollenlager, Raddurchmesser 100mm, Laufflächenbreite 22mm; Bauhöhe 128mm; Tragkraft 90kg		1.200	1,57

<p>383q40K125vK2351</p>	<p>TwinCasters with central Total Lock, Plastic polyamide housing (RAL9010), and precision bb in the forkhead; TPU tyre, ShoreA95, wheel diameter 125 mm, load capacity 120kg, total height 150mm, fitting 2351 / explanation below the list</p> <p>Doppelrolle mit zentralem Totalfeststeller, Gehäuse Kunststoff (RAL9010) und Schwenklager mit Präzisionskugellager; TPU Bandage ShoreA95, Raddurchmesser 125 mm; Kugellager, Tragkraft 120 kg, Bauhöhe 150 mm; Befestigung 2351 / Erklärung am Ende der Liste</p>		<p>180</p>	<p>11,98</p>
<p>383q40K150vK985</p>	<p>TwinCasters with central Total Lock, Plastic polyamide housing (RAL9010), and precision bb in the forkhead; TPU tyre, ShoreA95, wheel diameter 150 mm, load capacity 150kg, total height 175mm, fitting 985 / explanation below the list</p> <p>Doppelrolle mit zentralem Totalfeststeller, Gehäuse Kunststoff (RAL9010) und Schwenklager mit Präzisionskugellager; TPU Bandage ShoreA95, Raddurchmesser 150 mm; Kugellager, Tragkraft 150 kg, Bauhöhe 175 mm; Befestigung 985 / Erklärung am Ende der Liste</p>		<p>900</p>	<p>15,22</p>
<p>383r40K150vK985</p>	<p>TwinCasters with central Total and Directional Lock, Plastic polyamide housing (RAL9010), and precision bb in the forkhead; TPU tyre, ShoreA95, wheel diameter 150 mm, load capacity 150kg, total height 175mm, fitting 985 / explanation below the list</p> <p>Doppelrolle mit zentralem Total- und Richtungsfeststeller, Gehäuse Kunststoff (RAL9010) und Schwenklager mit Präzisionskugellager; TPU Bandage ShoreA95, Raddurchmesser 150 mm; Kugellager, Tragkraft 150 kg, Bauhöhe 175 mm; Befestigung 985 / Erklärung am Ende der Liste</p>		<p>450</p>	<p>15,31</p>
<p>383r40K150yK985</p>	<p>antistatic TwinCasters with central Total and Directional Lock, Plastic polyamide housing (RAL9010), and precision bb in the forkhead; TPU tyre, ShoreA95, wheel diameter 150 mm, load capacity 150kg, total height 175mm, fitting 985 / explanation below the list</p> <p>antistatische Doppelrolle mit zentralem Total- und Richtungsfeststeller, Gehäuse Kunststoff (RAL9010) und Schwenklager mit Präzisionskugellager; TPU Bandage ShoreA95, Raddurchmesser 150 mm; Kugellager, Tragkraft 150 kg, Bauhöhe 175 mm; Befestigung 985 / Erklärung am Ende der Liste</p>	 antistatic / antistatische Version	<p>300</p>	<p>19,39</p>
<p>390q29K100yZ985X</p>	<p>Swivel castor with total brake; housing sheet steel metal zinc-passivated; double ball bearing in swivel head; antistatic TPU tyre, ShoreA95, wheel diameter 100mm, ball bearing, plastic wheel centre, load capacity 100kg, total height 133mm, fitting 985 / explanation below the list</p> <p>Lenkrolle mit zentralem Totalfeststeller; Gehäuse Stahlblech verzinkt-passiviert; Schwenklager mit zweireihigem Kugellauf; antistatische TPU Bandage ShoreA95, Raddurchmesser 100mm; Kugellager, Kunststoff-Radkörper, Tragkraft 100kg, Bauhöhe 133mm; Befestigung 985 / Erklärung am Ende der Liste</p>	 antistatic / antistatische Version	<p>550</p>	<p>10,99</p>
<p>390q29K100rZ985C</p>	<p>Swivel castor with total brake; housing sheet steel metal zinc-passivated; double ball bearing in swivel head; plastic Covers RAL 9010; TPE tyre, ShoreA80, wheel diameter 100mm, ball bearing, plastic wheel centre, load capacity 100kg, total height 133mm, fitting 985 / explanation below the list</p> <p>Lenkrolle mit zentralem Totalfeststeller; Gehäuse Stahlblech verzinkt-passiviert; Schwenklager mit zweireihigem Kugellauf; Kunststoff Cover RAL 9010; TPE Bandage ShoreA80, Raddurchmesser 100mm; Kugellager, Kunststoff-Radkörper, Tragkraft 100kg, Bauhöhe 133mm; Befestigung 985 / Erklärung am Ende der Liste</p>		<p>135</p>	<p>7,74</p>
<p>390r29K100rZ985C</p>	<p>Swivel castor with total and directional brake; housing sheet steel metal zinc-passivated; double ball bearing in swivel head; plastic Covers RAL 9010; TPE tyre, ShoreA80, wheel diameter 100mm, ball bearing, plastic wheel centre, load capacity 100kg, total height 133mm, fitting 985 / explanation below the list</p> <p>Lenkrolle mit zentralem Richtungs- und Totalfeststeller; Gehäuse Stahlblech verzinkt-passiviert; Schwenklager mit zweireihigem Kugellauf; Kunststoff Cover RAL 9010; TPE Bandage ShoreA80, Raddurchmesser 100mm; Kugellager, Kunststoff-Radkörper, Tragkraft 100kg, Bauhöhe 133mm; Befestigung 985 / Erklärung am Ende der Liste</p>		<p>45</p>	<p>7,89</p>
<p>390q29K125vZ985X</p>	<p>Swivel castor with total brake; housing sheet steel metal zinc-passivated; double ball bearing in swivel head; TPU tyre, ShoreA95, wheel diameter 125mm, ball bearing, plastic wheel centre, load capacity 100kg, total height 158mm, fitting 985 / explanation below the list</p> <p>Lenkrolle mit zentralem Totalfeststeller; Gehäuse Stahlblech verzinkt-passiviert; Schwenklager mit zweireihigem Kugellauf; TPU Bandage ShoreA95, Raddurchmesser 125 mm; Kugellager, Kunststoff-Radkörper, Tragkraft 100kg, Bauhöhe 158mm; Befestigung 985 / Erklärung am Ende der Liste</p>		<p>270</p>	<p>7,85</p>

<p>390r29K125yZ985X</p>	<p>antistatic Swivel castor with total and directional brake; housing sheet steel metal zinc-passivated; double ball bearing in swivel head; TPU tyre, ShoreA95, wheel diameter 125mm, ball bearing, plastic wheel centre, load capacity 100kg, total height 158mm, fitting 985 / explanation below the list</p> <p>antistatische Lenkrolle mit zentralem Richtungs- und Totalfeststeller; Gehäuse Stahlblech verzinkt-passiviert; Schwenklager mit zweireihigem Kugellauf; TPU Bandage ShoreA95, Raddurchmesser 125 mm; Kugellager, Kunststoff-Radkörper, Tragkraft 100kg, Bauhöhe 158mm; Befestigung 985 / Erklärung am Ende der Liste</p>	 antistatic / antistatische Version	<p>90</p>	<p>11,05</p>
<p>398q35K150vK985</p>	<p>Swivel Caster with central total brake; die-cast aluminium load-bearing housing; highly polished plastic cover; precision ball bearings in the fork head; TPU tyre, ShoreA95, wheel diameter 150mm, ball bearing, plastic wheel centre, load capacity 150kg, total height 188mm, fitting 985 / explanation below the list</p> <p>Lenkrolle mit zentralem Totalfeststeller, tragendem Gehäuse aus Aluminium-Druckguss, hochglanzpolierte Kunststoff-Abdeckung; Präzisionskugellager im Gabelkopf; TPU Bandage ShoreA95, Raddurchmesser 150 mm; Kugellager, Kunststoff-Radkörper, Tragkraft 150kg, Bauhöhe 188mm; Befestigung 985 / Erklärung am Ende der Liste</p>		<p>180</p>	<p>16,27</p>
<p>398q35K150vK2351ZA</p>	<p>Swivel Caster with central total brake; die-cast aluminium load-bearing housing; highly polished plastic cover; precision ball bearings in the fork head; TPU tyre, ShoreA95, wheel diameter 150mm, ball bearing, plastic wheel centre, load capacity 150kg, total height 188mm, fitting 2351 / explanation below the list</p> <p>Lenkrolle mit zentralem Totalfeststeller, tragendem Gehäuse aus Aluminium-Druckguss, hochglanzpolierte Kunststoff-Abdeckung; Präzisionskugellager im Gabelkopf; TPU Bandage ShoreA95, Raddurchmesser 150 mm; Kugellager, Kunststoff-Radkörper, Tragkraft 150kg, Bauhöhe 188mm; Befestigung 2351 / Erklärung am Ende der Liste</p>		<p>600</p>	<p>13,15</p>
<p>398r35K150vK2351ZA</p>	<p>Swivel Caster with central total and directional brake; die-cast aluminium load-bearing housing; highly polished plastic cover; precision ball bearings in the fork head; TPU tyre, ShoreA95, wheel diameter 150mm, ball bearing, plastic wheel centre, load capacity 150kg, total height 188mm, fitting 2351 / explanation below the list</p> <p>Lenkrolle mit zentralem Total- und Richtungsfeststeller, tragendem Gehäuse aus Aluminium-Druckguss, hochglanzpolierte Kunststoff-Abdeckung; Präzisionskugellager im Gabelkopf; TPU Bandage ShoreA95, Raddurchmesser 150 mm; Kugellager, Kunststoff-Radkörper, Tragkraft 150kg, Bauhöhe 188mm; Befestigung 2351 / Erklärung am Ende der Liste</p>		<p>200</p>	<p>13,27</p>
<p>600a29K125rKPF</p>	<p>Swivel Caster, Plastic iron grey (RAL7011), special solid bearing supported with ball bearing, top plate 95x70 mm; hole distance 75x45/72x52 mm; hole diameter 9 mm, TPE tyre, wheel diameter 125 mm; total height 164mm, load capacity 100kg</p> <p>Lenkrolle Kunststoff eisengrau (RAL7011), Spezialgleitlager mit Kugel abgestützt, Platte 95x70 mm; Lochmaß 75x45/72x52 mm; Lochgröße 9 mm, 125mm Rad mit TPE Bandage; Bauhöhe 164mm, Tragfähigkeit 100kg</p>		<p>227</p>	<p>6,98</p>



Befestigung 985
fitting 985

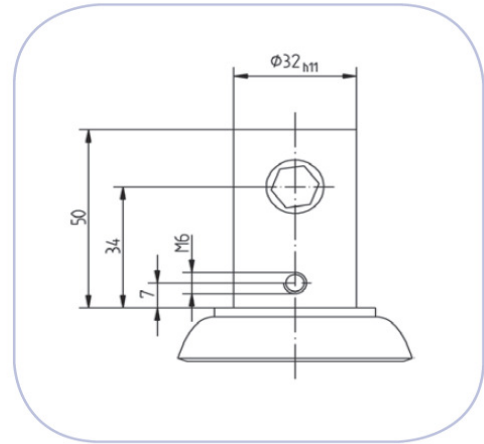
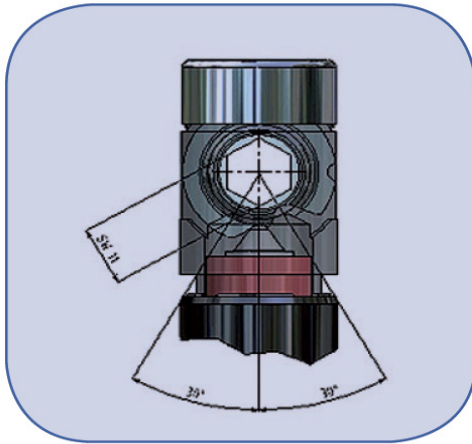

Befestigung 2351
fitting 2351

